

MAX-BAR 6mm 35° SERIES TOOLING



PLUNGE & TURN

(REG. U.S. PATENT)
 (NO. 5,779,400)
 (NO. 6,033,158)

WITH ONE TOOLHOLDER
 JUST CHANGE INSERT

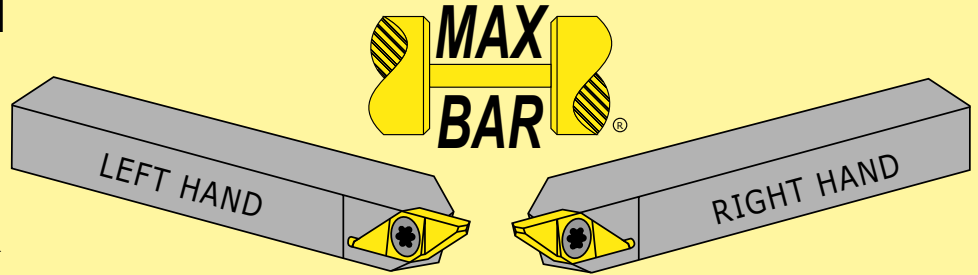

PLUNGE & TURN

RIGHT HAND SHOWN

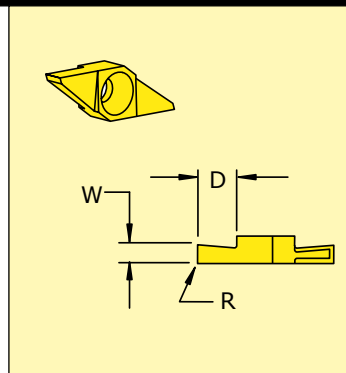

R.H. INSERT NO.	L.H. INSERT NO.	WIDTH		DEPTH		RADIUS	
		INCH	MM	INCH	MM	INCH	MM
VTGR-6M020	VTGL-6M020	.020	0,51	.030	0,76	.000	0,00
VTGR-6M031	VTGL-6M031	.031	0,78	.050	1,27	.000	0,00
VTGR-6M040	VTGL-6M040	.040	1,00	.075	1,90	.000	0,00
VTGR-6M047	VTGL-6M047	.047	1,20	.085	2,16	.000	0,00
VTGR-6M062	VTGL-6M062	.062	1,57	.130	3,30	.000	0,00
VTGR-6M078	VTGL-6M078	.078	2,00	.200	5,00	.000	0,00
VTGR-6M093	VTGL-6M093	.093	2,36	.200	5,00	.000	0,00

TOOLHOLDERS

RIGHT HAND SHOWN

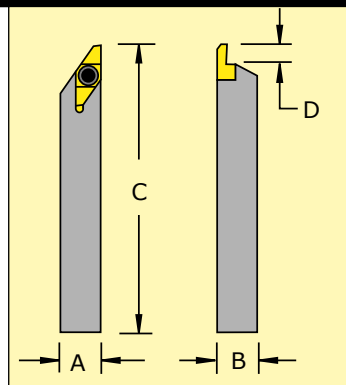

R.H. HOLDER NO.	L.H. HOLDER NO.	A	B	C	D
SVANR-07M6M-C	SVANL-07M6M-C	7mm	7mm	127mm	5mm
SVANR-08M6M-C	SVANL-08M6M-C	8mm	8mm	127mm	5mm
SVANR-10M6M-C	SVANL-10M6M-C	10mm	10mm	127mm	5mm
SVANR-12M6M-C	SVANL-12M6M-C	12mm	12mm	127mm	5mm
SVANR-3756M-C	SVANL-3756M-C	.375	.375	5.00	.200
SVANR-5006M-C	SVANL-5006M-C	.500	.500	5.00	.200
SVANR-6256M-C	SVANL-6256M-C	.625	.625	5.00	.200
SVANR-7506M-C	SVANL-7506M-C	.750	.750	5.00	.200
SPARE PARTS	SCREW 2.40-064	WRENCH T-7			

MAX-BAR 6mm 35° DIAMOND BARS

FOR TURRET & GANG LOADING/BACK WORKING

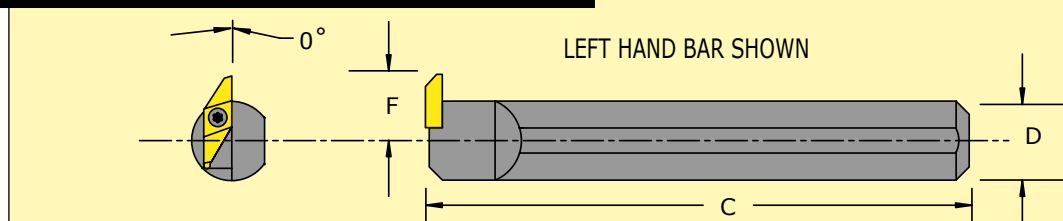

R.H. BAR NO.	L.H. BAR NO.	INSERT	D	C	F	SCREW	WRENCH
S10D-SVFNR6M	S10D-SVFNL6M	6MM-35	.625	5.75	.515	2.40-064	T-7
S12D-SVFNR6M	S12D-SVFNL6M	6MM-35	.750	5.75	.575	2.40-064	T-7

NOTE: RIGHT HAND BARS USE LEFT HAND INSERTS/LEFT HAND BARS USE RIGHT HAND INSERTS

MAX-BAR 8mm 35° SERIES TOOLING



PLUNGE & TURN

RIGHT HAND SHOWN

(SQUARE BOTTOM)

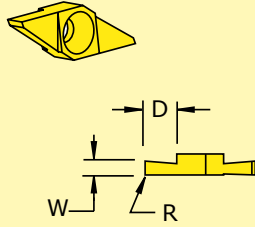

		WIDTH		DEPTH		RADIUS	
R.H. INSERT NO.	L.H. INSERT NO.	INCH	MM	INCH	MM	INCH	MM
VTGR-8M125	VTGL-8M125	.125	3,18	.300	7,62	.000	0,00
VTGR-8M093	VTGL-8M093	.093	2,36	.300	7,62	.000	0,00
VTGR-8M078	VTGL-8M078	.078	1,98	.250	6,35	.000	0,00
VTGR-8M062	VTGL-8M062	.062	1,57	.190	4,82	.000	0,00
VTGR-8M047	VTGL-8M047	.047	1,19	.130	3,30	.000	0,00
VTGR-8M031	VTGL-8M031	.031	0,78	.050	1,27	.000	0,00

TOOLHOLDERS

RIGHT HAND SHOWN

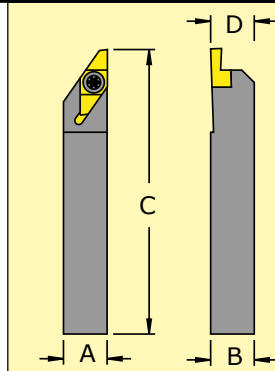

R.H. HOLDER NO.	L.H. HOLDER NO.	A	B	C	D
SVANR-3758M-V	SVANL-3758M-V	.375	.375	3.50	.380
SVANR-3758M-C	SVANL-3758M-C	.375	.375	5.00	.380
SVANR-10M8M-C	SVANL-10M8M-C	10mm	10mm	127mm	10mm
SVANR-12M8M-C	SVANL-12M8M-C	12mm	12mm	127mm	12mm
SVANR-5008M-V	SVANL-5008M-V	.500	.500	3.50	.505
SVANR-5008M-C	SVANL-5008M-C	.500	.500	5.00	.505
SVANR-6258M-C	SVANL-6258M-C	.625	.625	5.00	.630
SPARE PARTS		SCREW 3.20-095		WRENCH T-10	

MAX-BAR 10 SERIES TOOLING

FOR BAR DIAMETERS UP TO 3/8" (10 MM)

TOOLHOLDERS

RIGHT HAND SHOWN

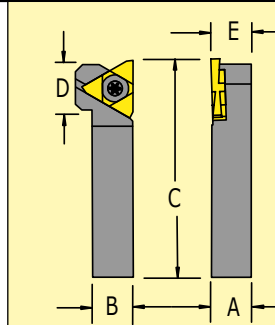

R.H. Holder No.	L.H. Holder No.	A	B	C	D	E
STANR-053-V	STANL-053-V	.312	.312	3.50	.550	.317
STANR-063-V	STANL-063-V	.375	.375	3.50	.550	.380
STANR-063-C	STANL-063-C	.375	.375	5.00	.550	.380
STANR-083-V	STANL-083-V	.500	.500	3.50	.550	.505
STANR-083-C	STANL-083-C	.500	.500	5.00	.550	.505
STANR-103-V	STANL-103-V	.625	.625	3.50	---	.630
SPARE PARTS		SCREW 3.50 - 095		WRENCH T-15		

PLUNGE & TURN

RIGHT HAND SHOWN

(SQUARE BOTTOM)

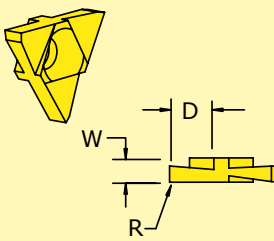

		WIDTH		DEPTH		RADIUS	
R.H. INSERT NO.	L.H. INSERT NO.	INCH	MM	INCH	MM	INCH	MM
TTGR-3125	TTGL-3125	.125	3,18	.230	5,84	0.00	0,00
TTGR-3093	TTGL-3093	.093	2,36	.230	5,84	0.00	0,00
TTGR-3078	TTGL-3078	.078	1,98	.230	5,84	0.00	0,00
TTGR-3062	TTGL-3062	.062	1,57	.230	5,84	0.00	0,00
TTGR-3047	TTGL-3047	.047	1,19	.130	3,30	0.00	0,00
TTGR-3030	TTGL-3030	.030	0,76	.090	2,28	0.00	0,00

MAX-BAR 16 SERIES TOOLING

FOR BAR DIAMETERS UP TO 5/8" (16mm)



PLUNGE & TURN

(SQUARE BOTTOM)

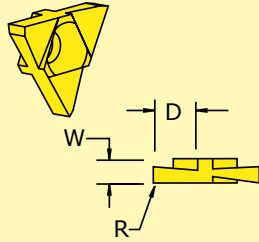

RIGHT HAND SHOWN

		WIDTH		DEPTH		RADIUS	
R.H. INSERT NO.	L.H. INSERT NO.	INCH	MM	INCH	MM	INCH	MM
TTGR-4125	TTGL-4125	.125	3,18	.350	8,90	0.00	0,00
TTGR-4093	TTGL-4093	.093	2,36	.350	8,90	0.00	0,00
TTGR-4078	TTGL-4078	.078	1,98	.300	7,62	0.00	0,00
TTGR-4062	TTGL-4062	.062	1,57	.230	5,84	0.00	0,00
TTGR-4047	TTGL-4047	.047	1,19	.130	3,30	0.00	0,00
TTGR-4031	TTGL-4031	.031	0,76	.090	2,28	0.00	0,00

TOOLHOLDERS

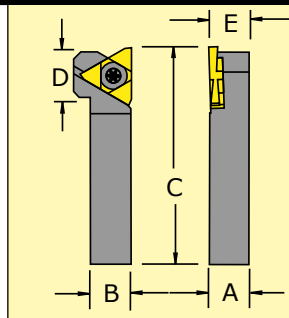

RIGHT HAND SHOWN

R.H. Holder No.	L.H. Holder No.	A	B	C	D	E
STANR-064-V *	STANL-064-V *	.375	.375	3.50	.750	.380
STANR-064-C *	STANL-064-C *	.375	.375	5.00	.750	.380
STANR-084-V	STANL-084-V	.500	.500	3.50	.750	.505
STANR-084-C	STANL-084-C	.500	.500	5.00	.750	.505
STANR-104-V	STANL-104-V	.625	.625	3.50	.750	.630
STANR-124-C	STANL-124-C	.750	.750	5.00	---	.755
SPARE PARTS		SCREW *4.06-095 4.06-127			WRENCH T-20	

MAX-BAR 20 SERIES TOOLING

FOR BAR DIAMETERS UP TO 3/4" (20mm)

PLUNGE & TURN

(SQUARE BOTTOM)

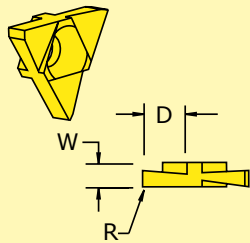

RIGHT HAND SHOWN

		WIDTH		DEPTH		RADIUS	
R.H. INSERT NO.	L.H. INSERT NO.	INCH	MM	INCH	MM	INCH	MM
TTGR-5156	TTGL-5156	.156	3,96	.440	11,2	0.00	0,00
TTGR-5125	TTGL-5125	.125	3,18	.440	11,2	0.00	0,00
TTGR-5093	TTGL-5093	.093	2,36	.370	9,40	0.00	0,00
TTGR-5078	TTGL-5078	.078	1,98	.300	7,62	0.00	0,00
TTGR-5062	TTGL-5062	.062	1,57	.230	5,84	0.00	0,00
TTGR-5047	TTGL-5047	.047	1,19	.130	3,30	0.00	0,00

TOOLHOLDERS

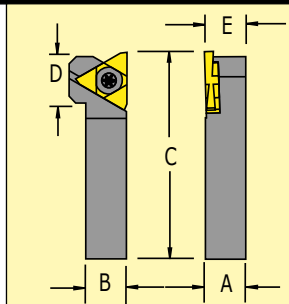

RIGHT HAND SHOWN

R.H. Holder No.	L.H. Holder No.	A	B	C	D	E
STANR-085-V	STANL-085-V	.500	.500	3.50	.920	.505
STANR-085-C	STANL-085-C	.500	.500	5.00	.920	.505
STANR-105-V	STANL-105-V	.625	.625	3.50	.920	.630
STANR-105-D	STANL-105-D	.625	.625	4.50	.920	.630
STANR-125-C	STANL-125-C	.750	.750	5.00	.920	.755
SPARE PARTS		SCREW 4.76-127			WRENCH T-25	

PLUNGE & TURN

RIGHT HAND SHOWN

(SQUARE BOTTOM)

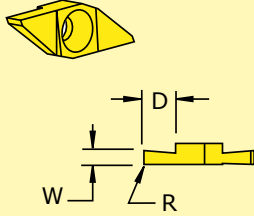

R.H. INSERT NO.	L.H. INSERT NO.	WIDTH		DEPTH		RADIUS	
		INCH	MM	INCH	MM	INCH	MM
KTGR-4125	KTGL-4125	.125	3,18	.300	7,62	.000	0,00
KTGR-4093	KTGL-4093	.093	2,36	.300	7,62	.000	0,00
KTGR-4078	KTGL-4078	.078	1,98	.250	6,35	.000	0,00
KTGR-4062	KTGL-4062	.062	1,57	.190	4,82	.000	0,00
KTGR-4047	KTGL-4047	.047	1,19	.130	3,30	.000	0,00

TOOLHOLDERS

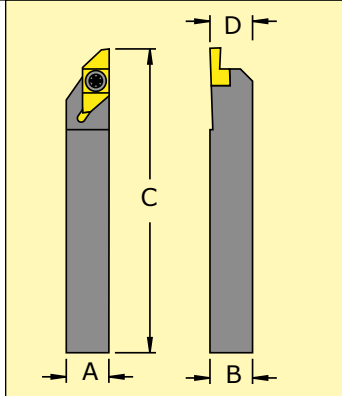

R.H. HOLDER NO.	L.H. HOLDER NO.	A	B	C	D
SKANR-104-V	SKANL-104-V	.625	.625	3.50	.630
SKANR-104-C	SKANL-104-C	.625	.625	5.00	.630
SKANR-124-V	SKANL-124-V	.750	.750	3.50	.755
SKANR-124-C	SKANL-124-C	.750	.750	5.00	.755
SKANR-164-C	SKANL-164-C	1.00	1.00	5.00	1.00
SPARE PARTS	SCREW 4.76-127	WRENCH T-25			

MAX-BAR RIGHT ANGLE HOLDERS

FOR TURRET & GANG LOADING

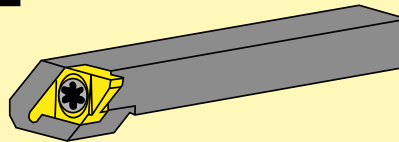
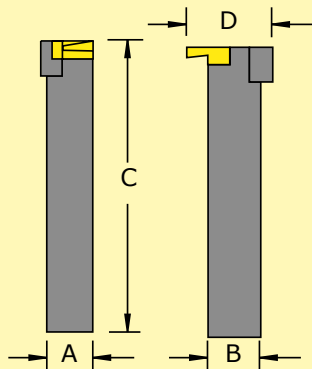

RIGHT HAND SHOWN

R.H. HOLDER NO.	L.H. HOLDER NO.	A	B	C	D	SCREW	WRENCH
SKFNR-064-D	SKFNL-064-D	.375	.500	4.50	1.15	4.76-127	T-25
SKFNR-084-D	SKFNL-084-D	.500	.500	4.50	1.15	4.76-127	T-25
SKFNR-104-D	SKFNL-104-D	.625	.625	4.50	1.15	4.76-127	T-25
SKFNR-124-C	SKFNL-124-C	.750	.750	5.00	1.05	4.76-127	T-25
SKFNR-164-C	SKFNL-164-C	1.00	1.00	5.00	1.30	4.76-127	T-25

NON-STANDARD SHANK SIZES AND RECTANGULAR SHANKS AVAILABLE ON REQUEST

NOTE: RIGHT HAND HOLDERS USE LEFT HAND INSERTS. LEFT HAND HOLDERS USE RIGHT HAND INSERTS.